



ATTREZZATURE PER EDILIZIA
EQUIPMENT FOR BUILDING INDUSTRY

SIRISET

SIRI CUT 3

SIRI FLEX 3

SIRI GUIDE 3

SIRI UP

SIRI MACHO

SIRI HULK

SIRI BENCH

SIRI TROLLEY



Grandi formati



Large tiles



Grands formats



Grossen fliesen



Sistema per tagli su lastre di grande formato.



System for cuts on ceramic and gres porcelain slabs.



Système à couper pour grands carreaux en ceramique et en grès cérame.





System für Schneiden von großen Fliesen von Keramik und Feinsteinzeug.

SIRI CUT 3

Made
in Italy

 SIRI CUT 3 è un sistema per il taglio di lastre di grande formato in ceramica e porcellanato. È composto da un carrello scorrevole con rotellina Ø mm 13 per l'incisione e da una pinza per separare. SIRI CUT va utilizzato su una delle SiriGuide 3 disponibili a scelta e NON INCLUSE. Grazie a quattro carrucole con cuscinetti a sfere, SIRI CUT 3 scorre facilmente sulle barre in acciaio delle guide; basterà una pressione sul pomello durante lo scorrimento sulla guida per incidere facilmente la piastrella. Si procede infine alla separazione con la pinza in dotazione. La pinza è dotata di regolazione dello spessore fino a 1 cm.

 SIRI CUT 3 is a system for cutting large ceramic and gres porcelain slabs. It consists of a sliding carriage with a 13 mm Ø wheel for cutting and pliers for separating. SIRI CUT 3 is to be used on one of the aluminium SIRIGUIDE available and NOT INCLUDED.

 Thanks to four ball bearing pulleys, SIRI CUT 3 slides smoothly along the guide steel bars and all you have to do is to press the knob slightly for an easy cut. The plier included can be adjusted for a thickness up to 1 cm and is to separate the tiles after the score.

 SIRICUT 3 est un système de coupe de plaques de grand format en céramique et en grès cérame. Il se compose d'un chariot coulissant avec une roue de Ø 13 mm pour la gravure et d'une pince de séparation ; SIRI-CUT 3 doit être utilisé sur une des SiriGuide disponibles. Grâce à quatre poulies avec roulements à billes, SIRICUT 3 coulisse facilement sur les rails en acier des guides. Il suffira d'une pression sur le bouton tournant pendant le coulisement sur le guide pour graver plus facilement le carreau. On procède enfin à la séparation avec la pince fournie. La pince est équipée d'un réglage de l'épaisseur jusqu'à 1 cm.

 SIRICUT 3 ist ein System zum Schnitt von großformatigen Keramik- und Feinsteinzeugplatten. Es besteht aus einem Gleitschlitten mit Rädchen Ø 13 mm für das Schnitt und einem Greifer zum trennen; SIRICUT 3 ist auf einer der verfügbaren SiriGuide zu verwenden. Dank vier Laufrollen mit Kugellagern gleitet SIRI-CUT 3 mit Leichtigkeit auf den Stahlstangen der Führungen; es reicht ein Drücken auf den Kugelgriff während des Gleitens auf der Führung, um die Fliese mühelos zu schneiden. Schließlich erfolgt das Trennen mit dem mitgelieferten Greifer. Der Greifer kommt mit ein System für Stärkeneinstellung bis 1 cm.

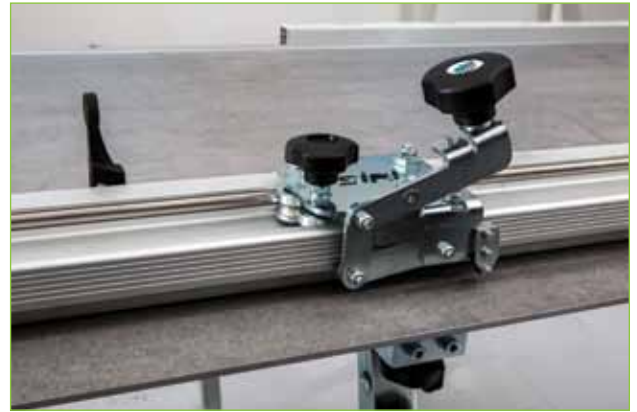

S.I.R.I. s.r.l.
41122 MODENA (ITALY) - Via Dalla Costa, 44 - info@siri.mo.it
Tel. 059 31 31 91 - Fax 059 31 13 62 - www.siri.mo.it

ADERENTE CONSORZIO EXPO-MODENA A MEMBER OF THE EXPO-MODENA CONSORTIUM
MEMBRE DU CONSORZIO EXPO-MODENA MITGLIED DER GENOSSENSCHAFT EXPO-MODENA

SIRI CUT 3



 Grandi formati
 Large tiles
 Grands formats
 Grossen fliesen

DATI TECNICI SPECIFICATIONS DONNÉES TECHNIQUES TECHNISCHE DATEN

Art.	Ref.						
6380	SIRI CUT 3	da 121 a 371 cm from 48" to 146"	da 0 a 8 mm from 0 to 5/16"	Ø 13 mm 1/2"	45 X 33 X 22 cm 18" X 12" X 8"	4,0	1 PCS

SIRI FLEX 3

Made
in Italy

 SIRI FLEX 3 è un sistema per il taglio di lastre di grande formato in ceramica porcellanato e marmo. È composto da un carrello scorrevole dove alloggiare una smerigliatrice angolare con disco diamantato e va utilizzato su una delle SiriGuide disponibili. Grazie a quattro carrucole con cuscinetti a sfere, SIRI FLEX 3 scorre facilmente sulle guide ed inoltre è dotato di movimento basculante per regolare la profondità di taglio. Il sistema, unico nel suo genere, è fornito di regolazione millimetrica. SIRI FLEX 3 può alloggiare gran parte delle smerigliatrici angolari presenti sul mercato ed è predisposto per l'utilizzo di un aspirapolvere.

 SIRI FLEX 3 is a system for cutting large ceramic gres porcelain and marble slabs. It consists of a sliding carriage for housing an angle grinder with diamond blade and to be used on one of available SiriGuide. Thanks to four ball bearing pulleys, SIRI FLEX 3 smoothly slides along the guides steel bars and it also has a swinging motion for adjusting the depth of the cut. Our system, is the only one of this kind, with a millimetric adjustment device. SIRI FLEX 3 can house most of the angle grinders that can be found on the market and is also designed for using a vacuum cleaner.

 SIRI FLEX 3 est un système de coupe de plaques de grand format en céramique et en grès cérame. Il se compose d'un chariot coulissant où loger une meuleuse d'angle avec un disque diamanté et doit être utilisé sur l'une des SiriGuide disponibles. Grâce à quatre poulies avec roulements à billes, SIRI FLEX 3 coulisse facilement sur les rails en acier des guides et est doté d'un mouvement de basculement pour régler la profondeur de coupe. Unique en son genre, le système est fourni avec un réglage millimétrique et deux étriers qui permettent d'effectuer une coupe à 90° et une coupe Jolly à 45°. SIRI FLEX 3 peut accueillir une grande partie des meuleuses d'angle présentes sur le marché et est pré-équipé pour l'utilisation d'un aspirateur.

 SIRI FLEX 3 ist ein System zum Schneiden von großformatigen Keramik- und Feinsteinzeugplatten. Es besteht aus einem Gleitschlitten zur Aufnahme eines Winkelschleifers mit Diamantscheibe und ist auf einer der verfügbaren SiriGuide zu verwenden. Dank vier Laufrollen mit Kugellagern gleitet SIRIFLEX 3 mit Leichtigkeit auf den Stahlstangen der Führungen und ist außerdem mit einer Schwenkbewegung zur Einstellung der Schnitttiefe ausgerüstet. Das einzigartige System verfügt über eine MillimeterEinstellung und zwei Bügel, die den 90°-Linearschnitt und den 45°-Jollyschnitt ermöglichen. SIRI FLEX 3 kann den größten Teil der auf dem Markt vorhandenen Winkelschleifer aufnehmen und ist für die Verwendung eines Staubsaugers vorbereitet.



S.I.R.I. s.r.l.
41122 MODENA (ITALY) - Via Dalla Costa, 44 - info@siri.mo.it
Tel. 059 31 31 91 - Fax 059 31 13 62 - www.siri.mo.it

ADERENTE CONSORZIO EXPO-MODENA A MEMBER OF THE EXPO-MODENA CONSORTIUM
MEMBRE DU CONSORZIO EXPO-MODENA MITGLIED DER GENOSSENSCHAFT EXPO-MODENA

SIRI FLEX 3



Art.6325-20

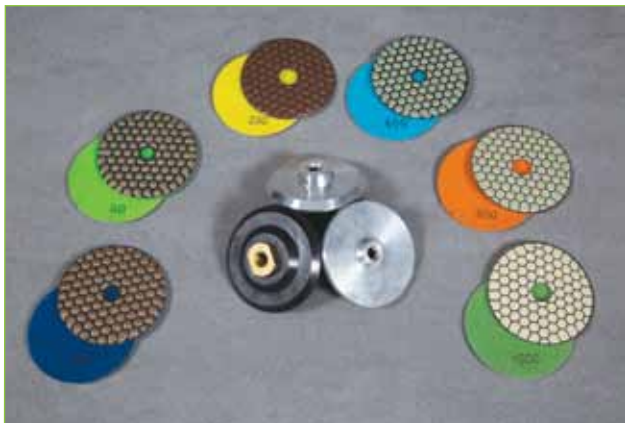
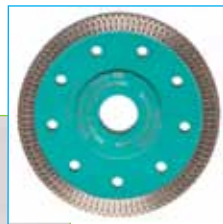

Art.6325-VS



Grandi formati



Large tiles



Grands formats



Grossen fliesen

DATI TECNICI SPECIFICATIONS DONNÉES TECHNIQUES TECHNISCHE DATEN

Art.	Ref.							
6350	SIRI FLEX 3	V230	da 121 a 371 cm from 48" to 146"	da 0 a 20 mm from 0 to 1"	Ø 115 - 125 mm 7/8" - 5"	60 X 41 X 26 cm 23" X 16" X 10"	9,5	1 PCS
6350A	SIRI FLEX 3	NO	da 121 a 371 cm from 48" to 146"	da 0 a 20 mm from 0 to 1"	Ø 115 - 125 mm 7/8" - 5"	60 X 41 X 26 cm 23" X 16" X 10"	8,5	1 PCS

SIRI GUIDE 3

Made in Italy

Le guide di scorrimento modulari in alluminio, disponibili in due lunghezze, sono dotate di un sistema interno per collegare i moduli, con attacco maschio o femmina. I moduli sono due, uno 120 cm e l'altro 180 cm e permettono di tagliare fino a 330 cm in base alla composizione. Ogni modulo è dotato di ventose, la cui posizione sulla guida è regolabile. Le gomme rigate delle ventose funzionano sulle superfici lisce e ruvide.

The modular aluminum sliding guides, available in two lengths, are equipped with an internal system to connect the modules, with male or female connection. There are two modules, one 120 cm and the other 180 cm and allow cutting up to 330 cm depending on the composition. Each module is equipped with suction cups, whose position on the guide is adjustable. The scored rubber of the suction cups work on smooth and rough surfaces.

Les guides modulaires en aluminium sont disponibles en deux longueurs et équipées d'un système interne de connexion des modules, avec mâle ou femelle. Il existe deux modules, un de 120 cm et l'autre de 180 cm, qui permettent de couper jusqu'à 330 cm en fonction de la composition. Chaque module est équipé de ventouses dont la position sur le guide est réglable. Les caoutchouc marqué des ventouses fonctionnent également sur des surfaces lisse et rugueuses.

Die modularen Aluminium-Gleitführungen, die in zwei Längen erhältlich sind, verfügen über ein internes System zur Verbindung der Module mit Stecker oder Buchse. zwei, eines 120 cm und das andere 180 cm und ermöglichen es Ihnen, je nach Zusammensetzung bis zu 330 cm zu schneiden. Jedes Modul ist mit Saugnapfen ausgestattet, deren Position auf der Führung einstellbar ist. Das eingeritzte Gummi der Saugnapfe arbeitet auf glatten und rauhen Oberflächen.

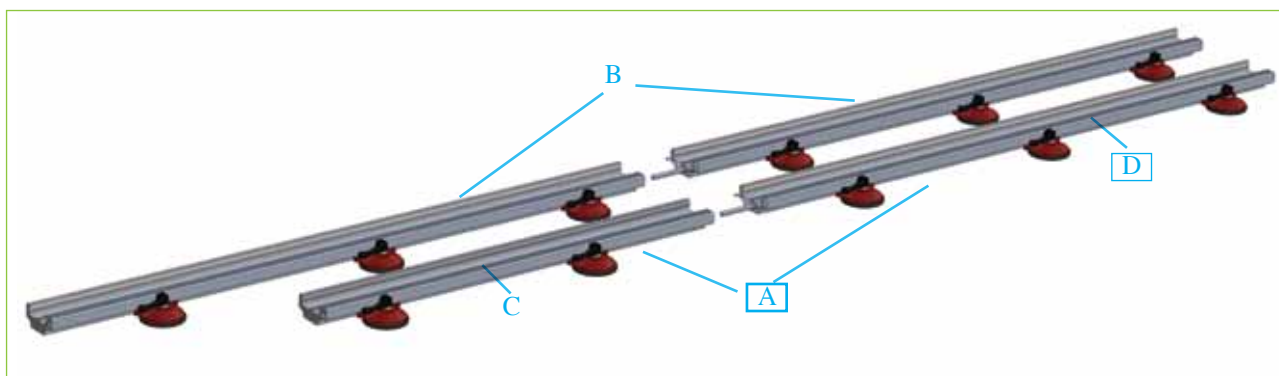

DATI TECNICI		SPECIFICATIONS		DONNÉES TECHNIQUES		TECHNISCHE DATEN			
Art.	Ref.	SIRIFLEX 3	SIRICUT 3						
A	17270GC	SIRI GUIDE MODULAR 270	cm 270 106"	cm 285 112"	cm 300 118"	5	cm 200 X 30 X H 20 79" X 12" X 8"	14	1 PCS
B	17330GC	SIRI GUIDE MODULAR 330	cm 330 130"	cm 345 136"	cm 360 142"	6	cm 200 X 30 X H 20 79" X 12" X 8"	15	1 PCS
C	17120GC	SIRI GUIDE MODULAR 120			cm 120 47"	2			1 PCS
D	17180GC	SIRI GUIDE MODULAR 180			cm 180 71"	3			1 PCS





S.I.R.I. s.r.l.
41122 MODENA (ITALY) - Via Dalla Costa, 44 - info@siri.mo.it
Tel. 059 31 31 91 - Fax 059 31 13 62 - www.siri.mo.it

ADERENTE CONSORZIO EXPO-MODENA A MEMBER OF THE EXPO-MODENA CONSORTIUM
MEMBRE DU CONSORZIO EXPO-MODENA MITGLIED DER GENOSSENSCHAFT EXPO-MODENA

SIRI UP



 Sistema di sollevamento per lastre di grande formato fino a cm 300 x 100. Telaio regolabile, con sistema a ventose per sollevare lastre con superfici levigate. SiriUp viene fornito da assemblare, per agevolare le condizioni di trasporto; è composto da due parti di cm 150 utilizzabili singolarmente o assemblate.

 This is a system for lifting large slabs of up to 300 x 100 cm. Adjustable frame with a suction cup system for lifting smooth surface slabs. To facilitate transport, SiriUp is delivered unassembled; it consists of two parts measuring 150 cm each which can be used separately or assembled.







 Système de levage pour plaques de grand format jusqu'à 300 x 100 cm. Châssis réglable, avec un système à ventouses pour soulever des plaques aux surfaces polies et structurées. SiriUp est fourni démonté, de manière à faciliter les conditions de transport; il est composé de deux parties de 150 cm qui peuvent être utilisées séparément ou assemblées.

 Hubsystem für großformatige Platten bis zu 300 x 100 cm. Einstellbarer Rahmen mit Saugnapfsystem zum Anheben von Platten mit geschliffenen Oberflächen. SiriUp wird zum Zusammenbauen geliefert, um den Transport zu erleichtern; es besteht aus zwei Teilen von 150 cm, die einzeln oder zusammengebaut verwendbar sind.



DATI TECNICI SPECIFICATIONS DONNÉES TECHNIQUES TECHNISCHE DATEN

Art.	Ref.					
6400	SIRI UP 300	cm 300 X 100 118" X 40"	8	cm 180 X 25 X H 25 71" X 10" X 10"	20	1 PCS
6400-240	SIRI UP 240	cm 240 X 100 95" X 40"	8	cm 180 X 25 X H 25 71" X 10" X 10"	18	1 PCS
6400-150	SIRI UP 150	cm 150 X 100 59" X 40"	4	cm 180 X 25 X H 25 71" X 10" X 10"	12	1 PCS





S.I.R.I. s.r.l.
41122 MODENA (ITALY) - Via Dalla Costa, 44 - info@siri.mo.it
Tel. 059 31 31 91 - Fax 059 31 13 62 - www.siri.mo.it

ADERENTE CONSORZIO EXPO-MODENA A MEMBER OF THE EXPO-MODENA CONSORTIUM
MEMBRE DU CONSORZIO EXPO-MODENA MITGLIED DER GENOSSENSCHAFT EXPO-MODENA

SIRI MACHO







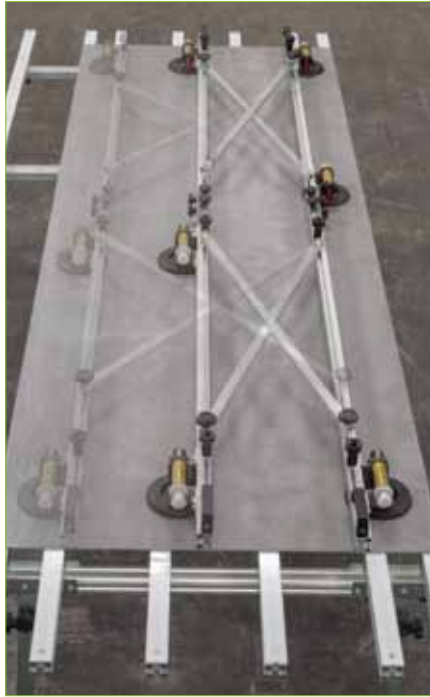

 Sistema di sollevamento per lastre di grande formato fino a cm 300 x 100. Telaio regolabile, con sistema di ventose a pompa e indicatore di perdita, per sollevare lastre con superfici ruvide e levigate. SiriMacho viene fornito da assemblare, per agevolare le condizioni di trasporto; è composto da due parti di cm 150 utilizzabili anche singolarmente. Il carico massimo verticale di sollevamento è di 40 kg per ogni ventosa.

 This is a system for lifting large slabs up to 300 x 100 cm. Adjustable frame with a pump suction system and cup fault indicator, for lifting slabs with rough and smooth surfaces. To facilitate transport, SiriMacho is delivered unassembled; it consists of two parts measuring 150 cm each which can also be used separately. The maximum vertical load that can be lifted is 40 kg for each suction cup.

 Système de levage pour plaques de grand format jusqu'à 300 x 100 cm. Châssis réglable, avec un système de ventouses à pompe et indicateur de perte, pour soulever des plaques à surfaces rugueuses ou polies. SiriMacho est fourni démonté, de façon à faciliter les conditions de transport ; il est composé de deux parties de 150 cm pouvant même être utilisées séparément. La charge verticale maximum de levage est de 40 kg pour chaque ventouse.

 Hubsystem für großformatige Platten bis 300 x 100 cm. Einstellbarer Rahmen mit Saugnapfsystem mit Pumpe und Verlustanzeiger zum Anheben von Platten mit rauen und geschliffenen Oberflächen. SiriMacho wird zum Zusammenbauen geliefert, um den Transport zu erleichtern; es besteht aus zwei Teilen von 150 cm, die auch einzeln verwendbar sind. Die maximale vertikale Hublast beträgt 40 kg für jeden Saugnapf.



DATI TECNICI		SPECIFICATIONS	DONNÉES TECHNIQUES	TECHNISCHE DATEN		
Art.	Ref.					
6400O-300	SIRI MACHO 300	cm 300 X 100 118" X 40"	6	cm 180 X 25 X H 25 71" X 10" X 10"	22,50	1 PCS
6400O-240	SIRI MACHO 240	cm 240 X 100 95" X 40"	6	cm 180 X 25 X H 25 71" X 10" X 10"	20,00	1 PCS
6400O-150	SIRI MACHO 150	cm 150 X 100 59" X 40"	4	cm 180 X 25 X H 25 71" X 10" X 10"	13,00	1 PCS



Grandi formati



Large tiles



Grands formats





Grossen fliesen

SIRI HULK



 Sistema di sollevamento per lastre di grande formato fino a cm 320 x 160. Telaio regolabile, con sistema di ventose a pompa e indicatore di pressione, per sollevare lastre con superfici ruvide e levigate.

 This is a system for lifting large slabs up to 320 x 160 cm. Adjustable frame with a pump suction system and pressure indicator, for lifting slabs with rough and smooth surfaces.

 Système de levage pour plaques de grand format jusqu'à cm 320 x 160. Châssis réglable, avec un système à ventouses avec indicateur de pression pour soulever des plaques aux surfaces polies et structurées.

 Hubsystem für großformatige Platten bis zu 320 x 160 cm. Verstellbarer Rahmen mit Absaugpumpesystem mit Druckanzeige und Manometer, für Höbe der platten mit polierten und strukturierten Oberflächen.



DATI TECNICI SPECIFICATIONS DONNÉES TECHNIQUES TECHNISCHE DATEN

Art.	Ref.					
6422	SIRI HULK	cm 200 X 320 79" X 126"	3	cm 220 X 25 X H 25 87" X 10" X 10"	12	1 PCS
6420	SIRI HULK TWINS	cm 200 X 320 79" X 126"	6	cm 220 X 50 X H 25 87" X 20" X 10"	24	1 PCS





S.I.R.I. s.r.l.
41122 MODENA (ITALY) - Via Dalla Costa, 44 - info@siri.mo.it
Tel. 059 31 31 91 - Fax 059 31 13 62 - www.siri.mo.it

ADERENTE CONSORZIO EXPO-MODENA A MEMBER OF THE EXPO-MODENA CONSORTIUM
MEMBRE DU CONSORZIO EXPO-MODENA MITGLIED DER GENOSSENSCHAFT EXPO-MODENA

SIRI HULK MAX



 Sistema di sollevamento per lastre di grande formato fino a cm 320 x 160. Telaio regolabile, con sistema di ventose a pompa, indicatore di pressione e vuotometro, per sollevare lastre con superfici ruvide e levigate.





 This is a system for lifting large slabs up to 320 x 160 cm. Adjustable frame with a pump suction system with pressure indicator and pressure gauge, for lifting slabs with rough and smooth surfaces.

 Système de levage pour plaques de grand format jusqu'à cm 320 x 160. Châssis réglable, avec un système à ventouses à pompe avec indicateur de pression et manomètre, pour soulever des plaques aux surfaces polies et structurées.

 Hubsystem für großformatige Platten bis zu 320 x 160 cm. Verstellbarer Rahmen mit Absaugpumpensystem mit Druckanzeige und Manometer, für Höhe der platten mit polierten und strukturierten Oberflächen.



DATI TECNICI SPECIFICATIONS DONNÉES TECHNIQUES TECHNISCHE DATEN

Art.	Ref.					
6492VT	SIRI HULK MAX	cm 200 X 320 79" X 126"	3	cm 220 X 25 X H 25 87" X 10" X 10"	12	1 PCS
6420VT	SIRI HULK MAX TWINS	cm 200 X 320 79" X 126"	6	cm 220 X 50 X H 25 87" X 20" X 10"	24	1 PCS

 Grandi formati

 Large tiles



 Grands formats

 Grossen fliesen

SIRI BENCH



 I banchi di lavoro modulari Siribench sono dotati di piani e traversi in trafilato d'alluminio a garanzia di stabilità e leggerezza. Vengono forniti di piedi dotati di un sistema di adattamento al terreno e di regolazione d'altezza. Grazie alle giunzioni disponibili, i banchi Siribench sono facilmente componibili fra loro, sia in lunghezza che in larghezza, per adattarsi alle dimensioni dei formati da tagliare, senza perdere le proprie caratteristiche di planarità. I banchi Siri vengono forniti da assemblare per agevolare le condizioni di trasporto. Su richiesta sono disponibili protezioni in polietilene per i trafilati che compongono il piano d'appoggio.

 The Siri modular work benches in aluminium have planking and cross pieces in drawn aluminium to guarantee lightness and stability. They are fitted with feet that can be height adjusted and adjusted to the ground. Thanks to the junctions that are available, the Siri workbenches are easily connected together, both in length and width which means they can be adapted to the dimensions of the sizes to be cut without detriment to flatness. The Siri workbenches are delivered unassembled to facilitate transport. Polyethylene guards are available upon request for the drawn parts (top of the workbench) and a carry case for transporting.

 Les établis modulaires Siri sont équipés de plans et de profilés d'aluminium, pour assurer stabilité et légèreté. Ils sont fournis avec des pieds munis d'un système d'adaptation au sol et de réglage de l'hauteur. Grâce aux articulations disponibles, les établis Siri sont faciles à assembler les uns aux autres, aussi bien en longueur qu'en largeur, pour s'adapter aux dimensions des formats à couper, sans perdre leurs caractéristiques de planéité. Les établis Siri sont fournis démontés pour faciliter le transport. Sur demande, nous pouvons fournir des protections en polyéthylène pour les profilés qui composent le plan d'appui.

 Die modularen Werktsche Siri verfügen über Bretter und Querstreben aus Aluminium, um Stabilität und Leichtigkeit zu gewährleisten. Sie werden mit Füßen geliefert, die mit einem Anpassungssystem an den Boden und Höheneinstellung ausgestattet sind. Dank der erhältlichen Verbindungsstücke lassen sich die Werkbänke von Siri einfach miteinander sowohl in der Länge, als auch in der Breite verbinden, um sich den Abmessungen der zu schneidenden Formate anzupassen, ohne ihre Planheitseigenschaften zu verlieren. Die Siri Werktsche werden zum Zusammenbauen geliefert, um den Transport zu erleichtern. Auf Anfrage sind Polyäthylenschutzvorrichtungen für die Querstreben, aus denen die Auflagefläche besteht.



S.I.R.I. s.r.l.

41122 MODENA (ITALY) - Via Dalla Costa, 44 - info@siri.mo.it

Tel. 059 31 31 91 - Fax 059 31 13 62 - www.siri.mo.it

ADERENTE CONSORZIO EXPO-MODENA A MEMBER OF THE EXPO-MODENA CONSORTIUM
MEMBRE DU CONSORZIO EXPO-MODENA MITGLIED DER GENOSSENSCHAFT EXPO-MODENA

SIRI BENCH



Grandi formati



Large tiles







Grands formats



Grossen fliesen

DATI TECNICI SPECIFICATIONS DONNÉES TECHNIQUES TECHNISCHE DATEN

Art.	Ref.				
6336	SIRI BENCHES 200	cm 200 x 100 H 85 79" x 39" H 33"	cm 210 X 25 X H 25 75" X 10" X 10"	32	1 PCS
6336-1	SIRI BENCHES 150	cm 150 x 100 H 85 59" x 39" H 33"	cm 160 X 25 X H 25 63" X 10" X 10"	27	1 PCS
6336-5	ESTENSIONE EXTENSION ERWEITERUNG 200	cm 200 x 25 H 85 79" x 10" H 33"	cm 210 X 25 X H 25 75" X 10" X 10"	5	1 PCS
6336-6	ESTENSIONE EXTENSION ERWEITERUNG 150	cm 150 x 25 H 85 59" x 10" H 33"	cm 160 X 25 X H 25 63" X 10" X 10"	5	1 PCS

SIRI TROLLEY

Made in Italy



Grandi formati



Large tiles



Grands formats



Grossen fliesen

SiriTrolley è un carrello in alluminio per la movimentazione delle lastre di grande formato, stabile e leggero. E' dotato di 4 ruote in gomma e di due posizioni di carico delle lastre, con base in legno antiscivolo e fermi di sicurezza. Il SiriTrolley viene fornito da assemblare, per agevolare il trasporto.





SiriTrolley is a lightweight and stable trolley in aluminium for handling large slabs. It has 4 rubber wheels and two slab loading positions; its base is in non-slip wood with safety stops. SiriTrolley is delivered unassembled to facilitate the transport.

SiriTrolley est un chariot en aluminium stable et léger, pour la manutention de plaques de grand format. Il est équipé de 4 roues en caoutchouc et deux positions de chargement des plaques, avec une base en bois antidérapant et des crans de sécurité. SiriTrolley est livré démonté, afin de faciliter les conditions de transport.

SiriTrolley ist ein stabiler und leichter Wagen aus Aluminium für das Bewegen großformatiger Platten. Er ist mit 4 Gummirädern und zwei Ladepositionen der Platten. Die Basis kommt mit rutschfestem Holz und Sicherheitsfeststellvorrichtungen. SiriTrolley wird zum Zusammenbauen geliefert, um den Transport zu erleichtern.



DATI TECNICI SPECIFICATIONS DONNÉES TECHNIQUES TECHNISCHE DATEN

Art.	Ref.				
6330	SIRI TROLLEY	cm 130 x 50 H 150 52" x 20" H 59"	cm 135 X 45 X H 30 53" X 18" X 12"	19,50	1 PCS



S.I.R.I. s.r.l.
41122 MODENA (ITALY) - Via Dalla Costa, 44 - info@siri.mo.it
Tel. 059 31 31 91 - Fax 059 31 13 62 - www.siri.mo.it

ADERENTE CONSORZIO EXPO-MODENA A MEMBER OF THE EXPO-MODENA CONSORTIUM
MEMBRE DU CONSORZIO EXPO-MODENA MITGLIED DER GENOSSENSCHAFT EXPO-MODENA